

PESO
WEIGHT

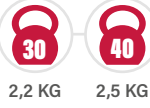

ROTAZIONE
ROTATION

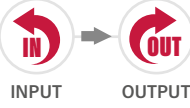

CARATTERISTICHE
FEATURES

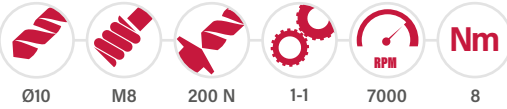

TA10.CP

TESTA AD ANGOLO - ANGLE HEAD

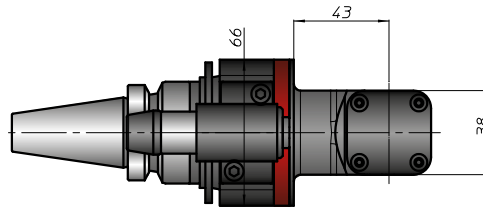
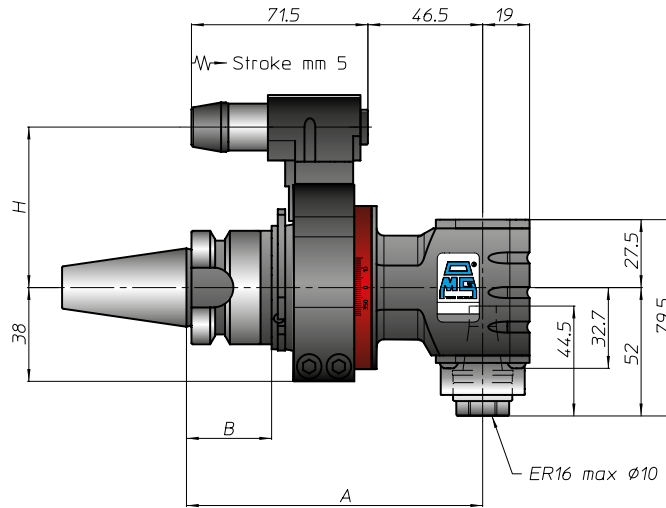
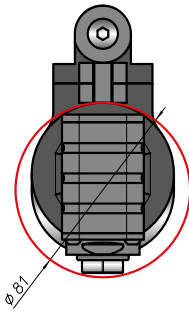

CONO
SHANK

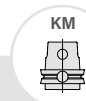
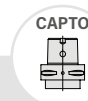

SIZE

30 40

40

30 40

63

ISO26623

DIN2080

ANSIB5.18

A

120

120

120

129

B

35

35

35

44

H STANDARD

65

65

65

65

H OPTIONAL

FH

BAH

TA.CP

TA

MOX

HT

3-4

VH

TSI/TSX

T

MT-TC-TC3

