

FH

BAH

TA.CP

TA

MOX

HT

4-57

VH

TSI/TSX

T

MT-TC-TC3



# TA10.PD

TESTA AD ANGOLO - ANGLE HEAD

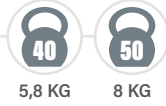
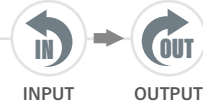
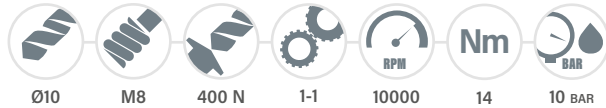
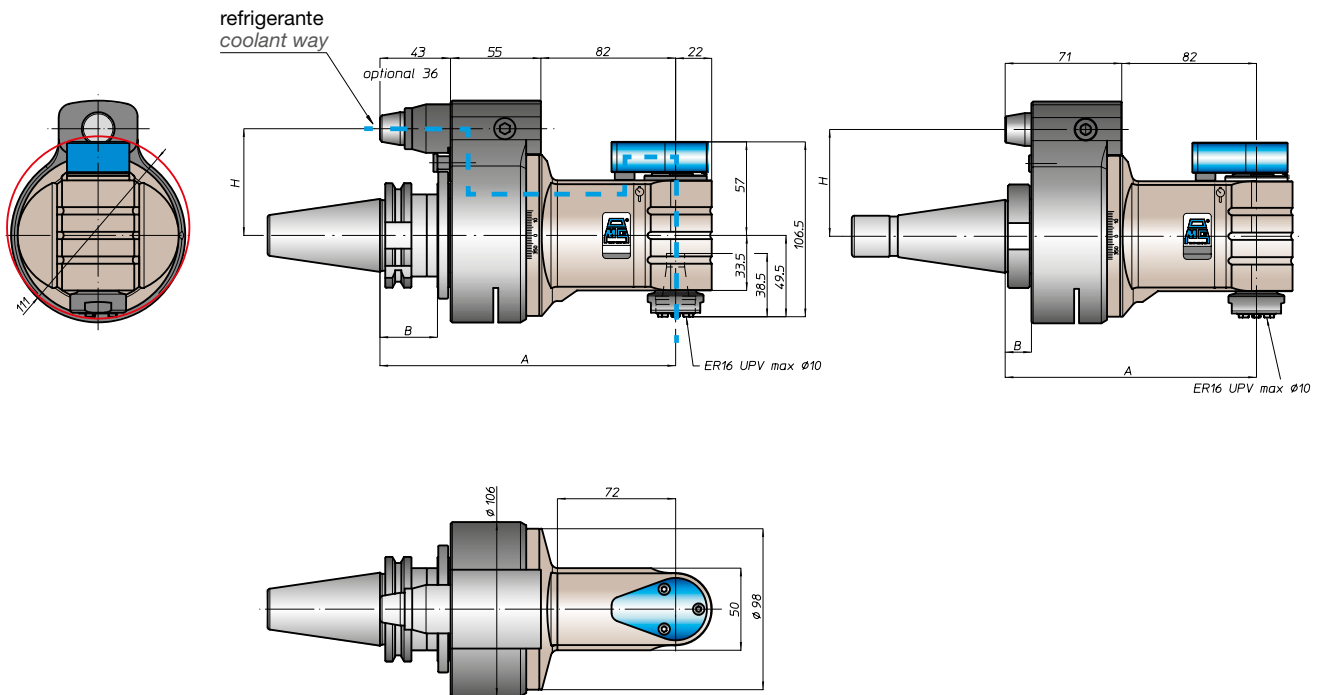
PESO  
WEIGHTROTAZIONE  
ROTATIONCARATTERISTICHE  
FEATURESCONO  
SHANK

DIN69871



ANSIB5.50



BT



HSK

DIN69893

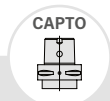

CAPTO

ISO26623

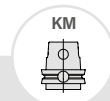

KM



DIN2080

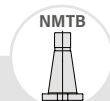

ANSIB5.18

SIZE

30 40 45 50 40 50 40 50 63 80 100

C5 C6 C8

63 80 100

40 50

40 50

A

180 180 180 188 189 184 180 150 153 150 153

B

35 35 35 45 44 46 39 41 13 16 13 16

H STANDARD

65 80 65 80 65 80 65 80 65 80 65 80 65 80

H OPTIONAL

110 110 110 110 110 110 110 110

For DIN69871, ANSIB5.50 and BT, dual contact as option

