

PESO
WEIGHT

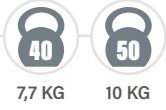

7,7 KG 10 KG

ROTAZIONE
ROTATION

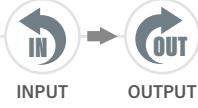

INPUT OUTPUT

CARATTERISTICHE
FEATURES

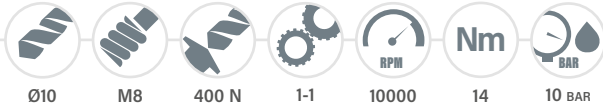

Ø10 M8 400 N 1-1 10000 14 10 BAR



TA10.PDL

TESTA AD ANGOLO - ANGLE HEAD

FH

BAH

TA.CP

TA

MOX

HT

refrigerante
coolant way

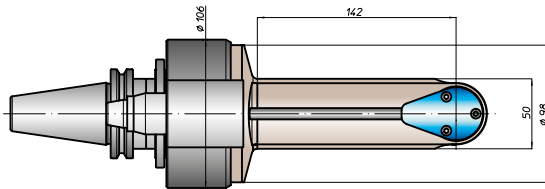
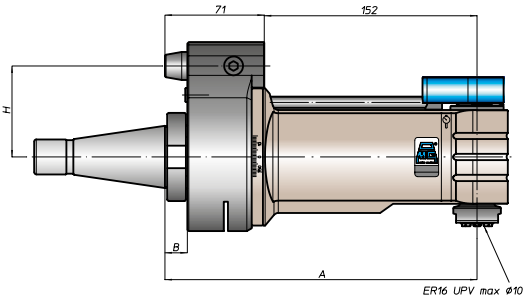
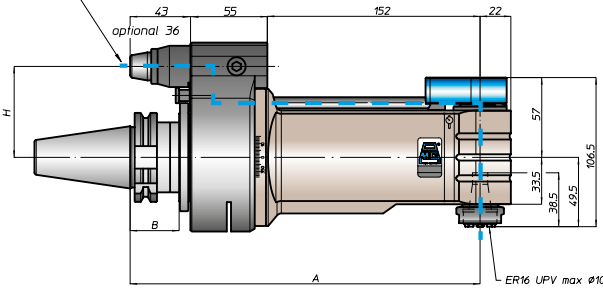
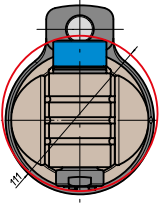

4-58

VH

TSI/TSX

T

MT-TC-TC3

CONO
SHANK

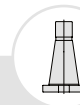
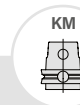
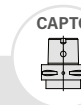
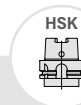

ANSIB5.50

DIN69893

ISO26623

DIN2080

ANSIB5.18

SIZE

40 45 50 40 50 40 50 63 80 100 C5 C6 C8 63 80 100 40 50 40 50

A

250 250 250 258 259 284 250 220 223 220 223

B

35 35 35 45 44 46 39 41 13 16 13 16

H STANDARD

65 80 65 80 65 80 65 80 65 80 65 80 65 80 65 80

H OPTIONAL

110 110 110 110 110 110 110 110

For DIN69871, ANSIB5.50 and BT, dual contact as option

