

FH

BAH

TA-CP

TA

MOX

HT

3-5

VH

TSI/TSX

T

MT-TC-TC3



TA13.CP

TESTA AD ANGOLO - ANGLE HEAD

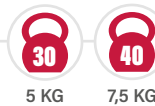

PESO
WEIGHT

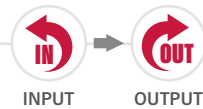

ROTAZIONE
ROTATION

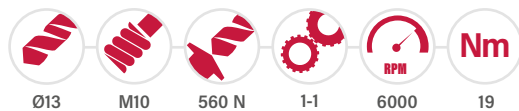

CARATTERISTICHE
FEATURES

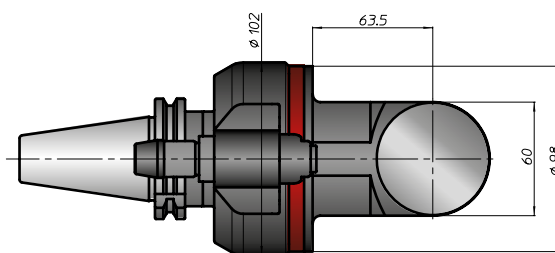
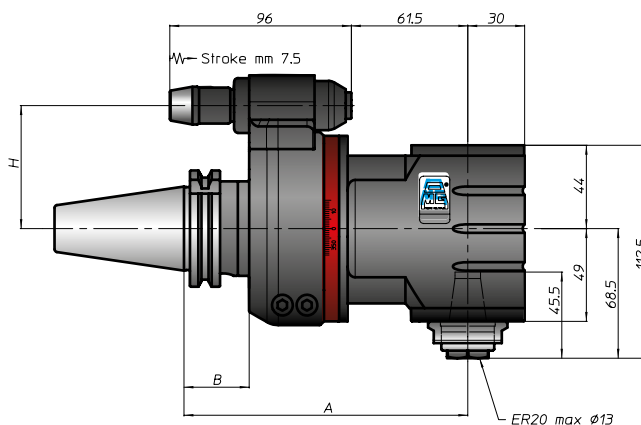
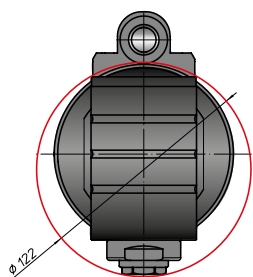

CONO
SHANK

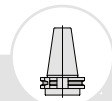

DIN69871



ANSIB5.50



BT



HSK

DIN69893

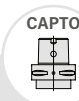

CAPTO

ISO26623

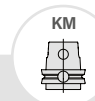

KM



DIN2080

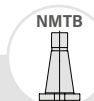

NMTB

ANSIB5.18

SIZE

30 40 45 50 40 50 40 50 63 80 100

A

150 150 150 158 159

B

35 35 35 45 44 46

H STANDARD

65 80 65 80 65 80 65 80

H OPTIONAL