

FH

BAH

TA.CP

TA

MOX

HT

3-7

VH

TSI/TSX

T

MT-TC-TC3



TA16.CP

TESTA AD ANGOLO - ANGLE HEAD

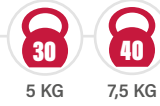

PESO
WEIGHT

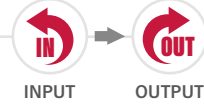

ROTAZIONE
ROTATION



CARATTERISTICHE
FEATURES

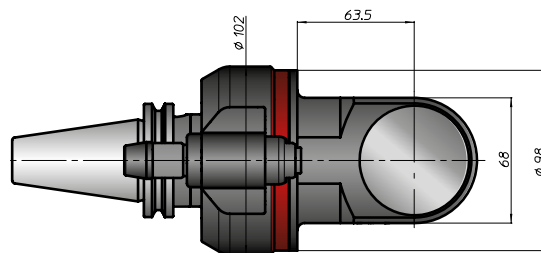
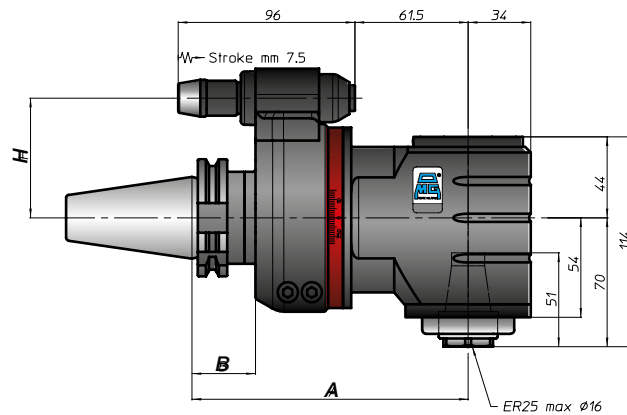
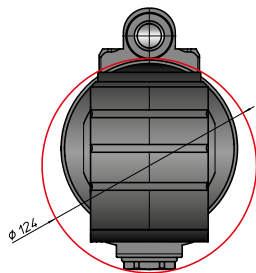

CONO
SHANK

SIZE

A

B

H STANDARD

H OPTIONAL



DIN69871



ANSIB5.50

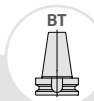

BT



DIN69893

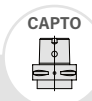

ISO26623



KM



DIN2080

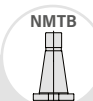

ANSIB5.18

| | | | | | | | | | | | | | |
|-----|----|-----|----|-----|-----|-----|----|----|-----|--|--|--|--|
| 40 | 45 | 50 | 40 | 50 | 40 | 50 | 63 | 80 | 100 | | | | |
| 150 | | 150 | | 150 | 158 | 159 | | | | | | | |
| 35 | | 35 | | 35 | 45 | 44 | 46 | | | | | | |
| 65 | 80 | | 65 | 80 | 65 | 80 | 80 | | | | | | |
| | | | | | | | | | | | | | |

