

FH

BAH

TA.CP

TA

MOX

HT

4-63

VH

TSI/TSX

T

MT-TC-TC3



TA26.40.D

TESTA AD ANGOLO - ANGLE HEAD



PESO

WEIGHT

22 KG



INPUT



OUTPUT

ROTAZIONE

ROTATION



Ø26



M20



3020 N



1-1



2500



165



40 BAR

CARATTERISTICHE

FEATURES

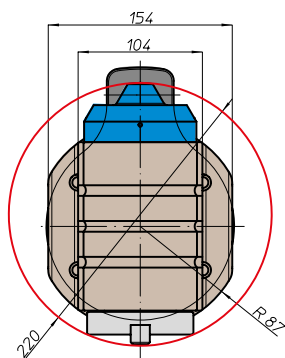

refrigerante

coolant way

optional

36

43

64

85

47.5

H

B

A

120

210.5

90.5

Cano 40 DIN2079

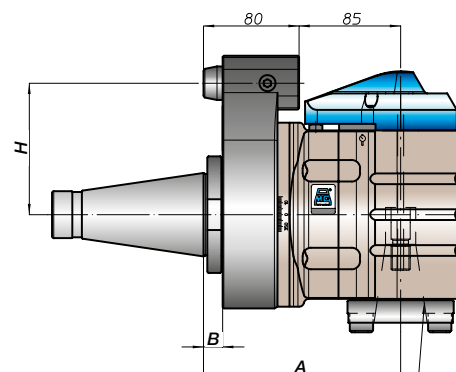

Cano 40 DIN2079

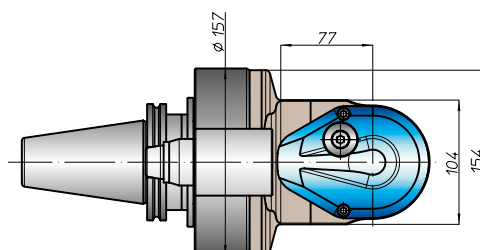

CONO

SHANK



DIN69871



ANSIB5.50



BT



HSK

DIN69893

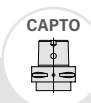

CAPTO

ISO26623

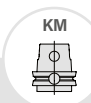

KM

100

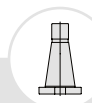

DIN2080

50

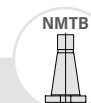

NMTB

ANSIB5.18

SIZE

45

50

50

50

80

100

C8

100

50

50

A

192

192

200

201

196

192

165

165

B

37

37

45

46

41

110

16

16

H STANDARD

110

110

110

110

110

110

110

H OPTIONAL

For DIN69871, ANSIB5.50 and BT, dual contact as option

