

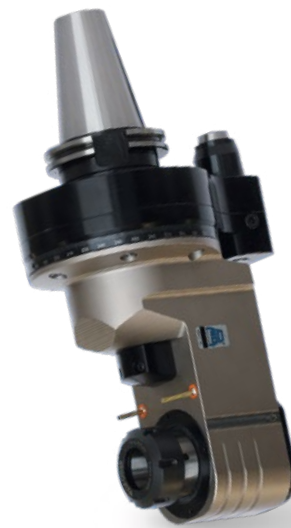

TAO26.PD

TESTA AD ANGOLO - ANGLE HEAD



PESO
WEIGHT



24 KG

ROTAZIONE
ROTATION

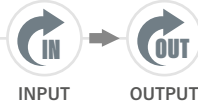

INPUT

OUTPUT

CARATTERISTICHE
FEATURES

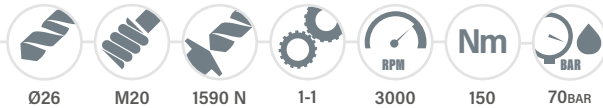

Ø26

M20

1590 N

1-1

3000

150

70 BAR

MANDRINI
DISPONIBILI
AVAILABLE
SPINDLES

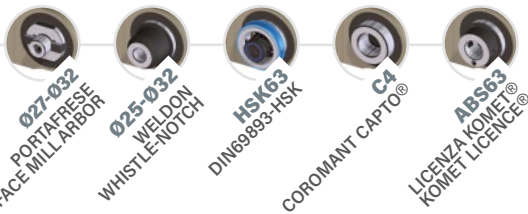

Ø27-Ø32

PORTAFRESE
FACE-MILL ARBOR

Ø25-Ø32

WELDON
WHISTLE-NOTCH

HSK63

DIN69893-HSK

C4

COROMANT CAPTO®

ABS63

LICENZA KOMET®
KOMET LICENCE®

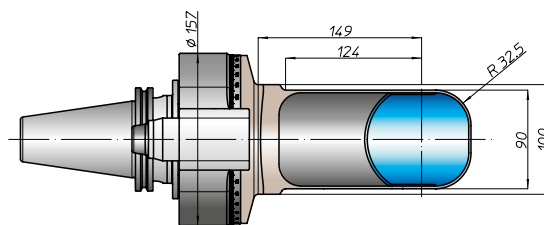
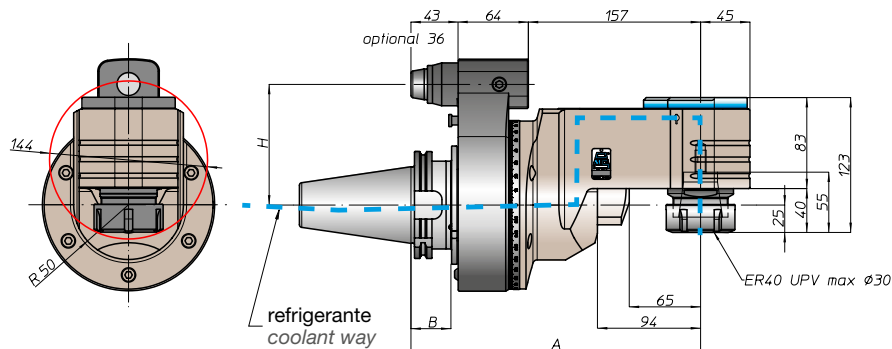

CONO
SHANK



DIN69871



ANSIB5.50



50



DIN69893

100

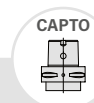

ISO26623

C8

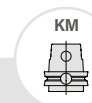

100

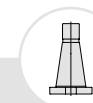

DIN2080

100



ANSIB5.18

SIZE

50

50

50

100

C8

100

100

A

264

264

272

273

264

270

B

36,5

36,5

44,5

45,5

36,5

H STANDARD

110

110

110

110

110

110

H OPTIONAL