

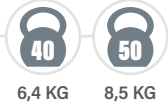

TAV10.PD

TESTA AD ANGOLO - ANGLE HEAD

PESO
WEIGHT



ROTAZIONE
ROTATION

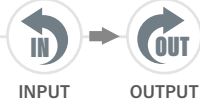

CARATTERISTICHE
FEATURES

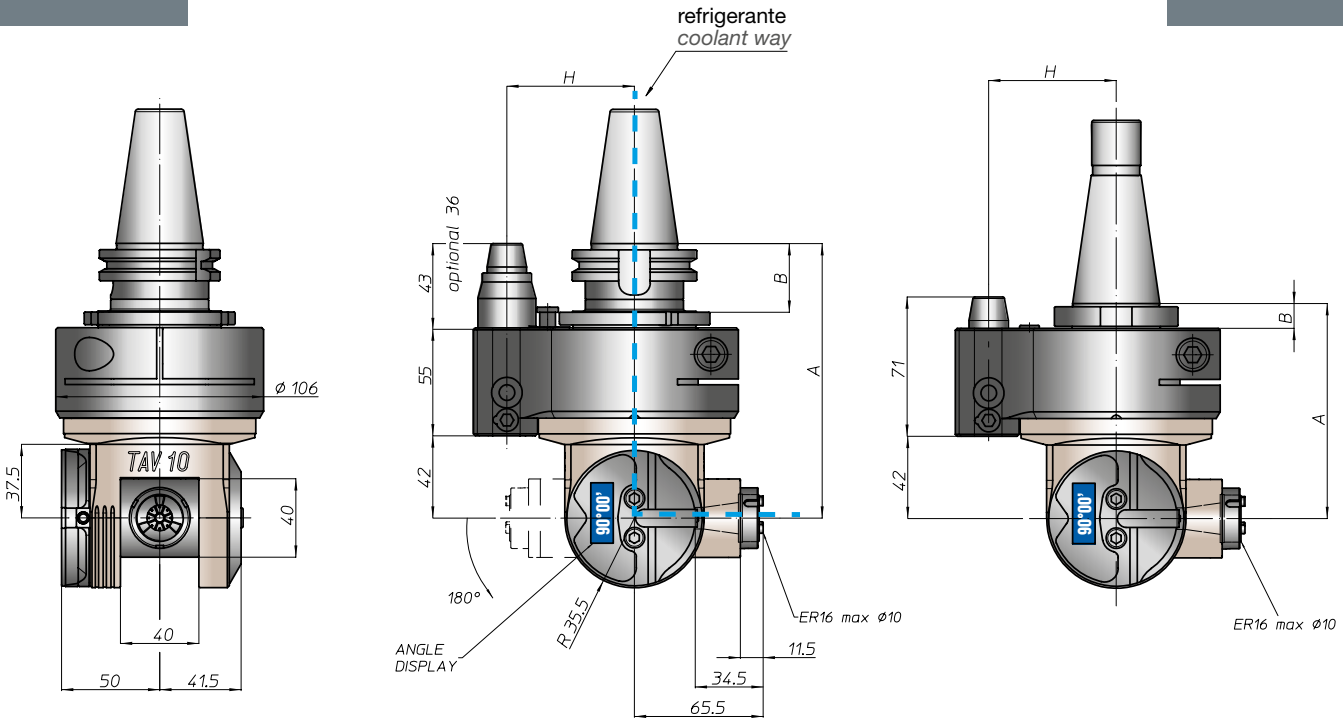
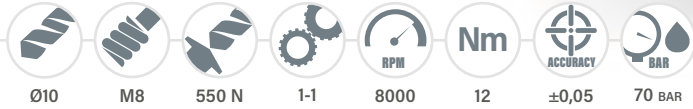

CONO
SHANK



DIN69871



ANSIB5.50



BT



HSK

DIN69893

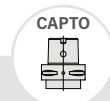

CAPTO

ISO26623

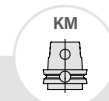

KM

DIN2080

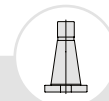

NMTB

ANSIB5.18

SIZE

40 45 50 40 50 40 50 63 80 100 C5 C6 C8 63 80 100 40 50 40 50

A

140 140 140 148 149 144 140 113 116 113 116

B

35 35 35 45 44 46 39 41 13 16 13 16

H STANDARD

65 80 65 80 65 80 65 80 65 80 65 80 65 80 65 80

H OPTIONAL

110 110 110 110 110 110 110 110

For DIN69871, ANSIB5.50 and BT, dual contact as option

4-78

VH

TSI/TSX

T

MT-TC-TC3



FH

BAH

TA-CP

TA

MOX

HT